

Tomsed Full Height Turnstiles



Versatile turnstiles for indoor and outdoor security

Our full height turnstile product range consists of several models that all offer excellent security control and can be installed indoors or outdoors depending on their type. Our full height security turnstiles, suitable for controlling unsupervised areas, are available in a wide range of custom widths, finishes and configurations to suit almost all buildings and environments.

A wide range of models from which to choose

Our full height turnstiles are available in both a 120°, 3-arm configuration or 90°, 4-arm configuration. The 3-arm models offer users more space and comfort, while the 4-arm models minimize the possibility of piggybacking by restricting the user to a smaller segment.

Single or tandem versions are available on most models. Optional side gates can be used to provide access for wheelchairs, bicycles or handcarts.

THT-100

Fabricated in a variety of durable materials, the THT-100 series provides dependable access control even in unsupervised locations.

Rugged, reliable construction

The THT-100 full height turnstiles are designed for high security areas where emphasis is placed on secure, controlled and unsupervised access. Their rugged construction ensures trouble-free performance and durability.

The heavy duty mechanism can be mechanical with optional self-centering, or electrical with standard self-centering. The electrical turnstiles are available in any combination of fail-lock or fail-safe.

Three rotor sections for 120° of passage space allow greater user comfort. A complementary access gate, the THG-51E, is available for handicapped or delivery traffic.

Model	Rotors	# Arms	Aesthetics
THT-100EC (Galvanized Steel)	Single	3 / 4	Basic-medium
THT-100ECP (Powder Coat)	Single	3 / 4	Basic-medium
THT-100EA (Stainless Steel/ Aluminum)	Single	3 / 4	Basic-medium
THT-100ES (Stainless Steel)	Single	3 / 4	Basic-medium



THT-100EC (custom width)



THG-51E ACCESS GATE

Standard dimensions and capacity

	A Passage width	B Overall height	C Overall width ¹	Capacity / minute ²
THT-100(3)	25 1/2"	89"	60"	15
THT-100(4)	20 3/16"	89"	60"	15

¹Custom widths available.

²Maximum capacity per minute indicates how many users can pass through in one direction with access control. Capacity per minute in one direction with free rotation is 20ppm.

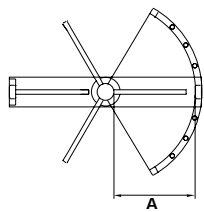

C

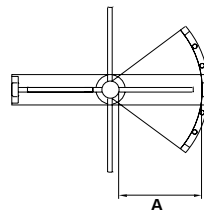

C

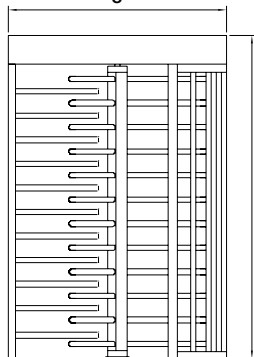

3-wing

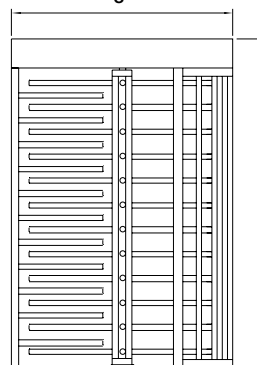

4-wing

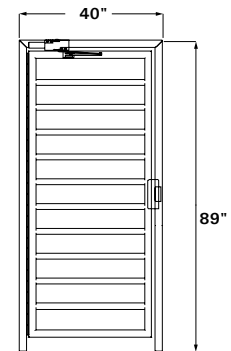

THG-51E

THT-100ASTG

These highly attractive and versatile turnstiles are designed for many years of reliable service. Fabricated from heavy gauge anodized aluminum, they feature extruded arms and clear, curved Lexan™ shields.

Reliable, comfortable and stylish

These full height turnstiles are available in several color schemes to provide aesthetic access control to any facility. The THT-100ASTG also is available with dual shields for an enhanced appearance.

Enhanced security with metal detection

The THT-100ASTGMD combines a fully integrated metal detection system with a dual shield ASTG turnstile for installations demanding accurate and efficient monitoring of persons carrying metal objects. There are two key-operated modes of operation:

1. Free passage through the turnstile unless a metal object is detected, in which case the turnstile locks and prevents passage.
2. Entry through turnstile contingent upon authorization from an access control system. If a metal detection alarm occurs, the access control reader is shunted and the turnstile remains locked.

Model	Rotors	# Arms	Aesthetics
THT-100ASTG	Single	3	Medium-high
THT-100ASTGMD (Metal Detection)	Single	3	Medium-high



Standard dimensions and capacity

	A Passage width	B Overall height	C Overall width	Capacity / minute ¹
THT-100ASTG	25 3/8"	89"	60"	15
THT-100ASTGMD	25 3/8"	89"	60"	15

¹Maximum capacity per minute indicates how many users can pass through in one direction with access control. Capacity per minute in one direction with free rotation is 20ppm.

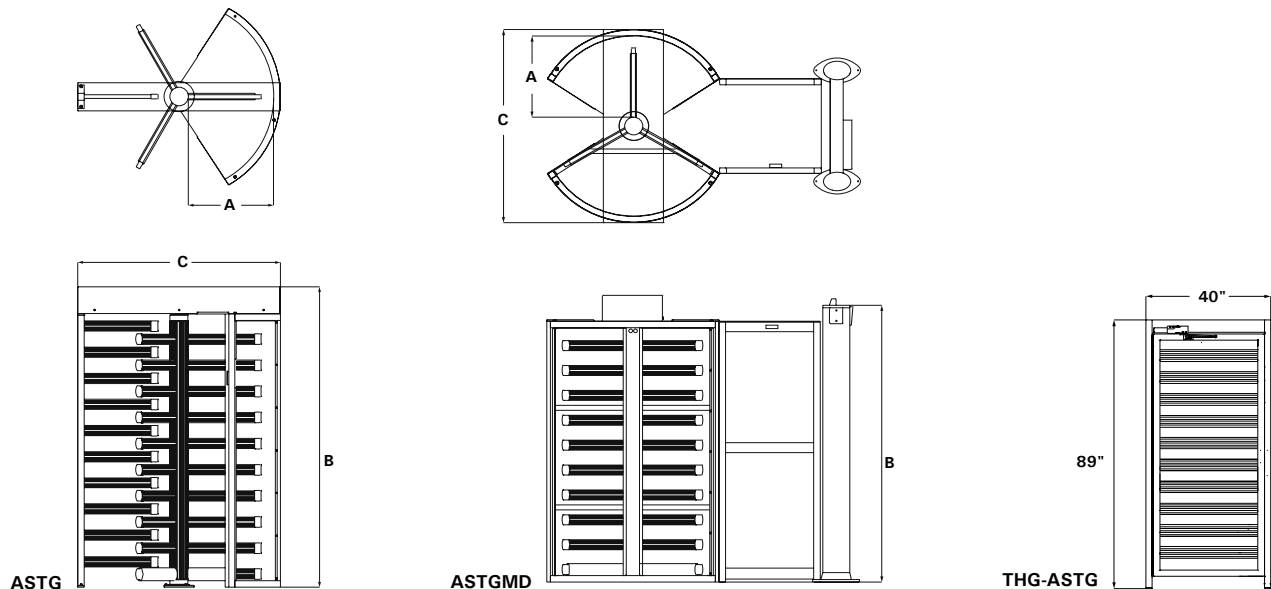

Transparent

Our transparent full height turnstiles offer the ideal solution for applications requiring structural integrity and impenetrability along with aesthetic appeal. The clear, see-through design achieves a clean, finished look. A transparent access gate, the THG-51EL is also available for handicapped or delivery traffic.

Security meets design

The THT-100EL utilizes clear arms and a curved Lexan™ shield assembly. A stainless steel round canopy provides the clean, finished look of a revolving door.

Enhanced aesthetic appeal

In lieu of many individual arms, the THT-100CSTG features three large clear panels per rotor section. The shield assembly also incorporates clear panels to enhance the aesthetic appeal.



THT-100EL with THG-51EL



THT-100CSTG

Model	Rotors	# Arms	Aesthetics
THT-100EL	Single	3 / 4	High
THT-100CSTG	Single	3	High

Standard dimensions and capacity

	A Passage width	B Overall height ¹	C Overall width ²	Capacity / minute ³
THT-100EL	25 ³ / ₈ "	89"	60"	15
THT-100CSTG	25 ³ / ₈ "	89"	60"	15

¹ Overall height includes hydraulic speed control.

² Custom widths available.

³ Maximum capacity per minute indicates how many users can pass through in one direction with access control. Capacity per minute in one direction with free rotation is 20ppm.

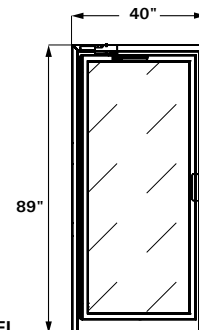
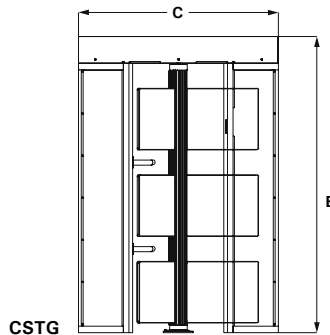
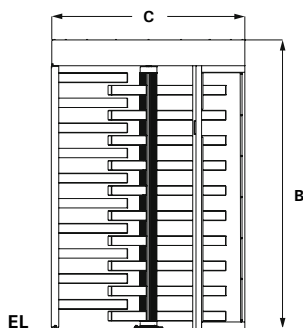
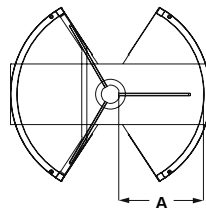
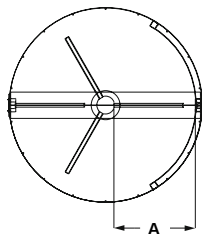

THG-51EL

Tandem turnstiles

Boon Edam's tandem full height turnstiles combine the functions of two single rotor turnstiles into one, space-saving turnstile.

Efficient tandem design

The intermeshing of left- and right-hand rotors allows a reduction in overall width from 10 feet (two single rotor turnstiles) to 8 feet with a space-saving double gate and no reduction of passage space. A 7-foot wide model is also available for smaller openings.

Three tandem models are available, based on the THT-100, THT-100ASTG and the THT-100EL (see table below). The THT-100T is available in galvanized steel, powder coat, stainless steel/aluminum and all stainless steel.

Model	Based on Model	# Arms	Aesthetics
THT-100T	THT-100	3 / 4	Basic-medium
THT-100TASTG	THT-100ASTG	3	Medium-high
THT-100TL	THT-100EL	3 / 4	High



Standard dimensions and capacity

	A Passage width 3-rotor / 4-rotor	B Overall height	C Overall width ¹	Capacity / minute ²
THT-100T	25½" / 20 ⅝"	89"	96"	2 x 15
THT-100TASTG	25⅜" / N/A	89"	96"	2 x 15
THT-100TL	24⅜" / 20 ⅝"	89"	96"	2 x 15

¹ Custom widths available.

² Maximum capacity per minute indicates how many users can pass through in one direction with access control. Capacity per minute in one direction with free rotation is 20ppm.

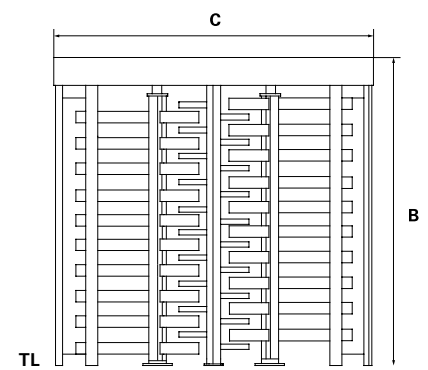
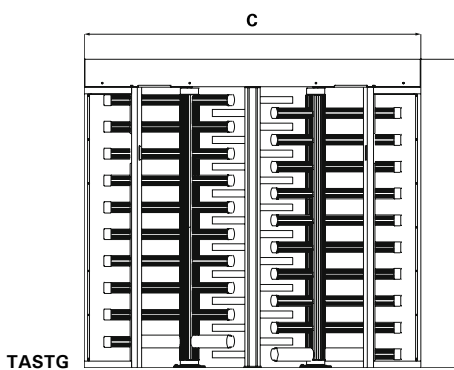
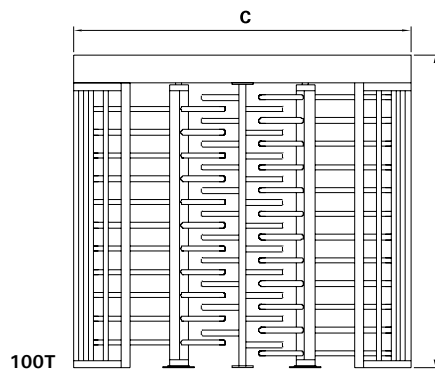
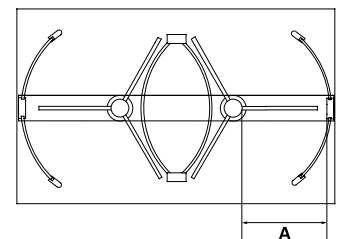
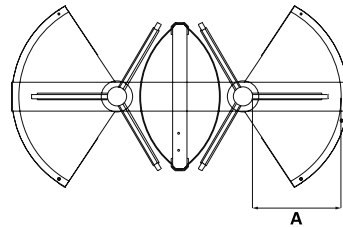
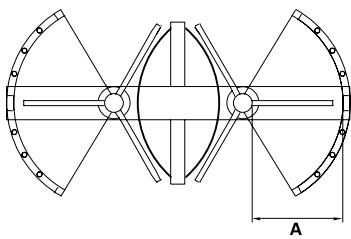

Features & options

	THT-100		THT-100ASTG		THT-100CSTG		THT-100EL	
	Std	Opt	Std	Opt	Std	Opt	Std	Opt
Mechanical and/or electrical turnstiles								
Second curved shield enclosure		•		•	•			•
Four arm sections		•		N/A		N/A		•
Powder coating in the desired color		•		N/A		N/A		•
Anodized aluminium in the color of choice		N/A		•		•		•
Key Bypass ¹		•		•		•		•
Stainless steel canopy (please call to discuss application)						•	•	
Out-of-use lock		•		N/A		N/A		N/A
Heel protectors		•		•		N/A		•
Rotor covers		•	•		•		•	
Tandem rotors		•		•		N/A		•
Electrical turnstiles								
Time-out relay	•		•		•		•	
Pulse relay	•		•		•		•	
Indicator lights (red/green) in the endpost of the turnstile (for each monitored direction)		•	•		•		•	
Rotation detection sensor per direction to create a transit signal for the authorization system		•		•		•		•
Home position switch		•		•		•		•
External push button (for each monitored direction)		•		•		•		•
Hydraulic speed control		•		•	•		•	
Card reader box		•		•		•		•

¹ Key bypass is standard with a Fail Lock configuration.

Technical specifications

Power supply ¹	110 VAC (220 VAC optional), 50/60 Hz Converted to 24 Volt
Power consumption ¹	Less than 1 amp at 110 VAC
Working temperature	5°F to 110°F
Weight (approx):	
THT-100(3).....	700 lbs
THT-100(4).....	750 lbs
THT-100T(3).....	1300 lbs
THT-100T(4).....	1500 lbs
ASTG	700 lbs
ASTGMD	1000 lbs
TASTG.....	1200 lbs
EL.....	1000 lbs
CSTG	1000 lbs
TL.....	2200 lbs
Connection	The electrical full height turnstile communicates with most authorization systems using potential free contacts.

¹Only for electrical models

High quality

At Boon Edam, we take quality seriously; the quality of the materials we use, the quality of our employees and the quality of our partners. As with all Boon Edam products, our full height turnstiles are manufactured to the highest standards, including all local, state and national codes.

Why Boon Edam?

Boon Edam is the largest producer of anti-tailgating security entrances in The Americas. We offer a broader product offering than any other company today. Boon Edam's 100+ years of success is due to an emphasis on quality design, and by providing unsurpassed customer service, support and training to its customers and reseller partners.

Boon Edam operates a policy of continuous refinement and improvement and therefore reserves the right to modify design and details at any time.

